

LED EXPLOSION PROOF LIGHT

Explosion Proof Outdoor LED Luminaire (C SERIES)



This LED Explosion Proof Light can provide general illumination in hazardous locations such as oil refineries, gasoline loading docks, distilleries, pumping stations, mines, vessels, paint manufacturing plants and other high humidity, high temperature, dusty locations.



DIMENSIONS

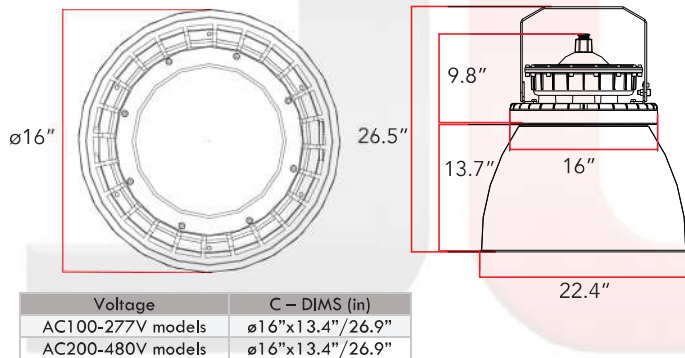

CERTIFICATIONS & RATINGS



- NEMA 4X, IP66
 - UL1598/UL1589A/UL844
 - CSA C22.2 No. 137/No.250.0
 - IECEx
 - ATEX
 - L70
- Class I, Division 1, Groups C,D
Class I, Division 2, Groups A,B,C,D
Class II, Division 1, Groups E,F,G
Class II, Division 2, Groups E,F,G
Class III

FEATURES

- Copper free aluminum
- High vibration resistance
- IP67 Waterproof
- Reduces energy consumption up to 60%
- Cree LED Chips
- Mean Well driver
- Wide and narrow optics for uniform illumination
- Surface mounting and pendant installations
- 5 Year Manufacturer's Warranty

COMMON TECHNICAL DATA

Color Temperature	4000K to 5700K
CRI	> 70
Beam Angle	40°, 60°, 90°, 120°
Operation Temperature	-40°C to 60°C
Efficiency	More than 140 LPW
Input Voltage	AC100-277V/200-480V
Frequency	50-60Hz
Power Factor	More than 0.90
Rated Life	150,000 hours
LED Type	Cree LED Chips

WARRANTY

This product has a warranty for a period of 5 years from the date of purchase. The warranty is invalid in the case of improper installation, tampering, or removal of the Q.C. date label. Installation in an improper working environment or installation not according to the current edition of the National Electric Code also invalidates the warranty. Should this product fail during the warranty period, it will be replaced free of charge, subject to correct installation and return of the faulty unit. JL Lighting does not accept responsibility for any installation costs associated with the replacement of this product. This warranty is in addition to the statutory rights in the country of purchase. JL Lighting reserves the right to alter specifications without prior notice.

LED EXPLOSION PROOF LIGHT

Explosion Proof Outdoor LED Luminaire (C SERIES)



PRODUCT SPECIFICATION

Product Number	Wattage	CCT	Voltage	Lumens	Working Hrs	CRI
JLX-60W CYZDA	60	4000K-5700K	AC100-277V or AC200-480V	8400	5 Years	70
JLX-80W CYZDA	80	4000K-5700K	AC100-277V or AC200-480V	11200	5 Years	70
JLX-100W CYZDA	100	4000K-5700K	AC100-277V or AC200-480V	14000	5 Years	70
JLX-150W CYZDA	150	4000K-5700K	AC100-277V or AC200-480V	21000	5 Years	70

ORDERING GUIDE

JLX	60W/80W/100W/150W	C	D/N	4000K-5700K	40°, 60°, 90°, 120°	C/Blank
Company Code	Wattage	Series	Y= Dimming Options	Z= CCT	D= Beam Angle	A= Long Glass Cover/ None

LIGHT DISTRIBUTION

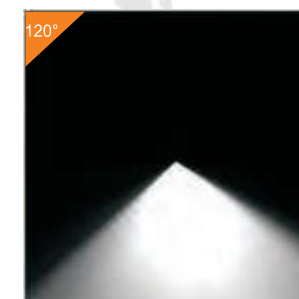
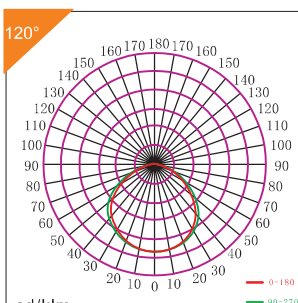
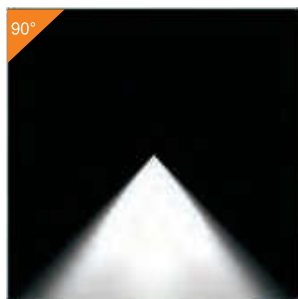
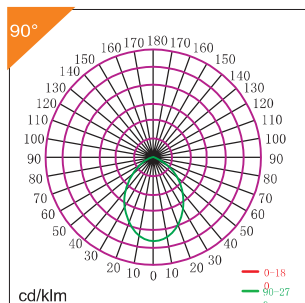
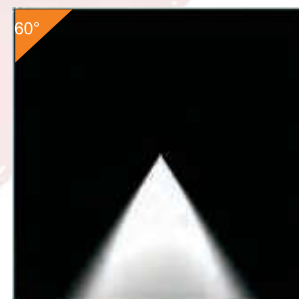
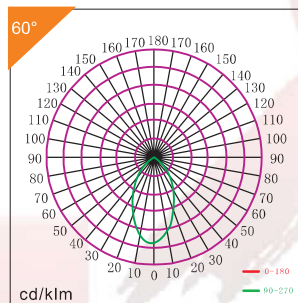
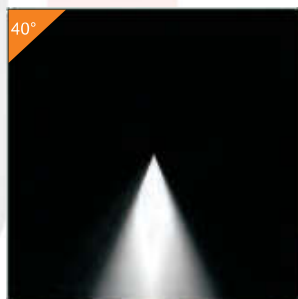
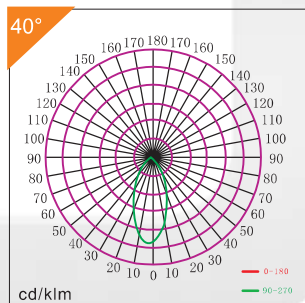

CAUTION

- Risk of fire- make sure power is OFF before installation.
- Risk of electric shock- make installation with gloves.
- All wiring needs to be performed per National Electrical Code and local code by a qualified electrician.
- These lamps can be used with a light dimmer.
- High temperatures inside luminaire make certain line voltage corresponds with ballast's primary voltage.
- If the lamp or luminaire exhibits undesirable operation (i.e. buzzing, flickering, etc.), immediately turn off power and remove the lamp from luminaire and contact manufacturer.
- Luminaires should not be installed in narrow space to guarantee enough air convection.
- Do not make mass installation before sample testing.

LED EXPLOSION PROOF LIGHT

Explosion Proof Outdoor LED Luminaire (C SERIES)



MOUNTING OPTIONS

